

KD-J 250K B 3N

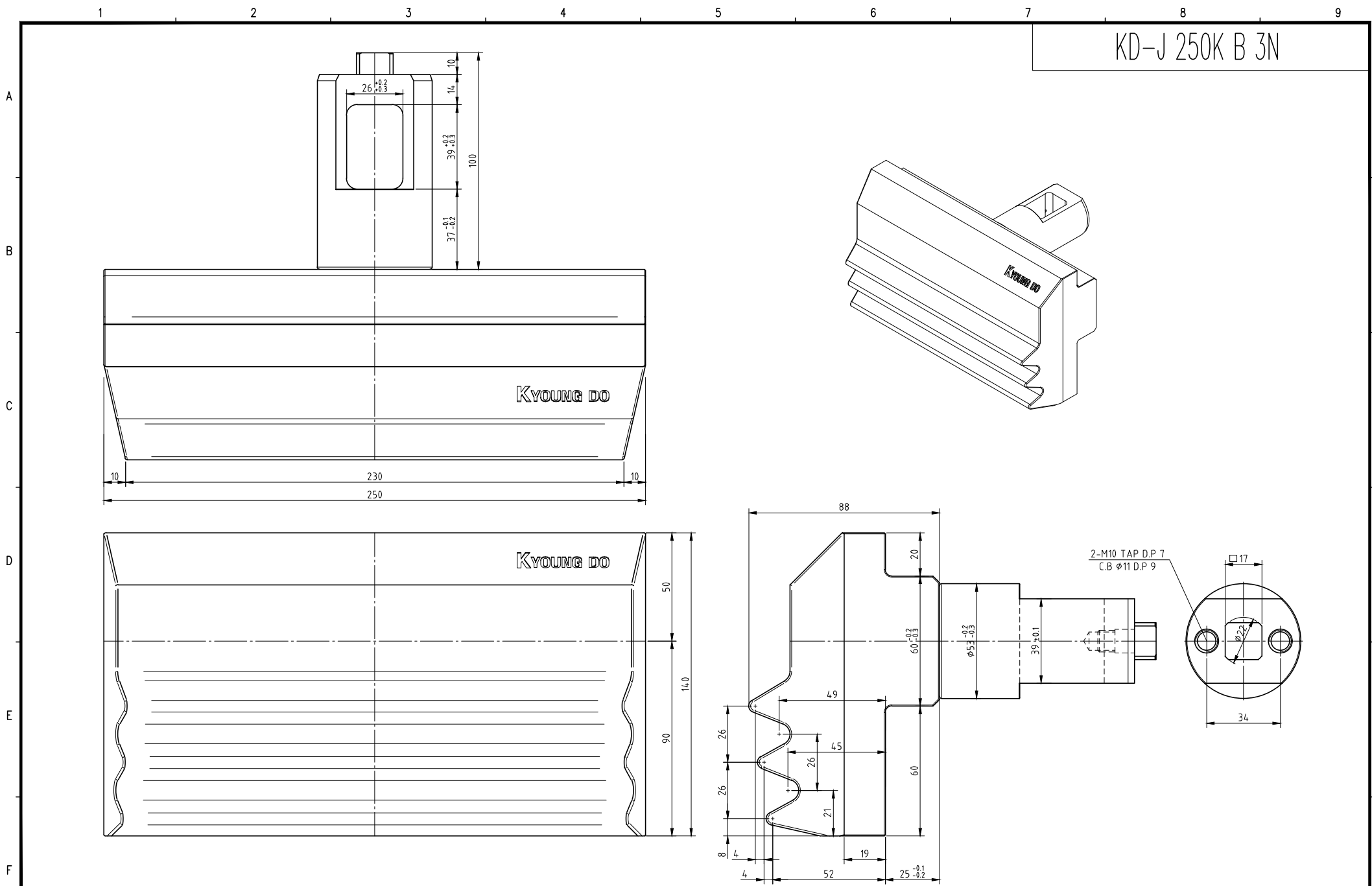

JAW / MAT'L : SKD61

SHAFT / MAT'L : SCM440

JAW / Q.T : Hs 70 ±3

SHAFT / Q.T : Hs 45 ±3