

KD-J 460P 2G 2N

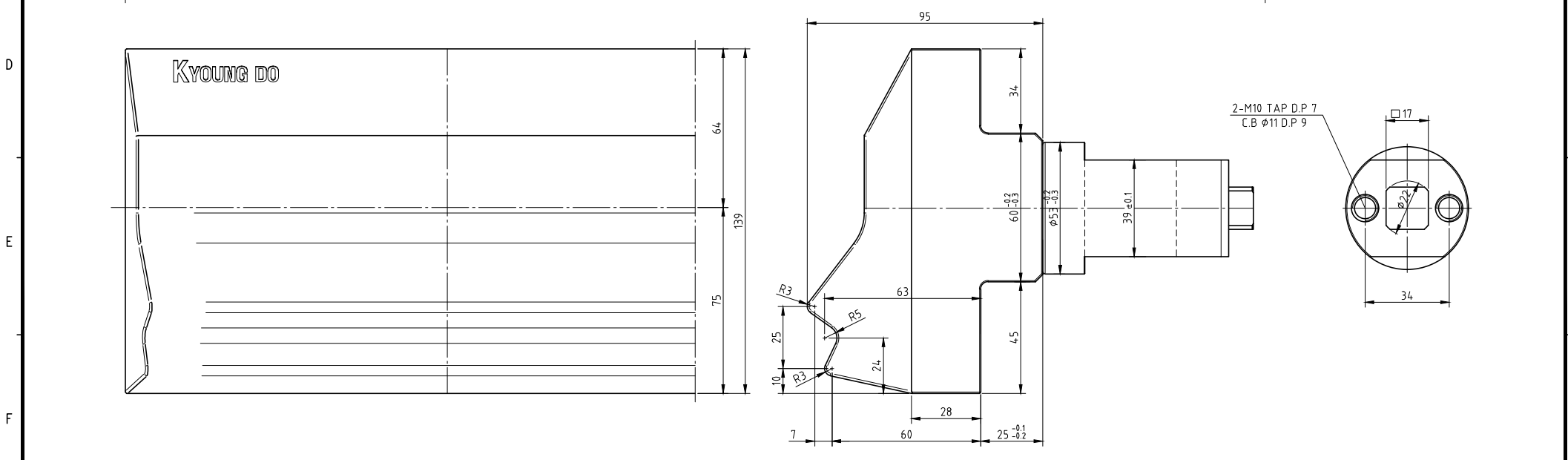
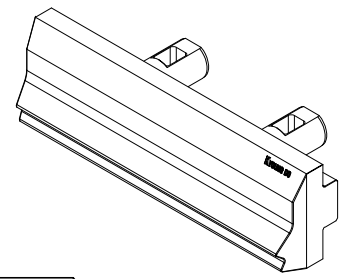
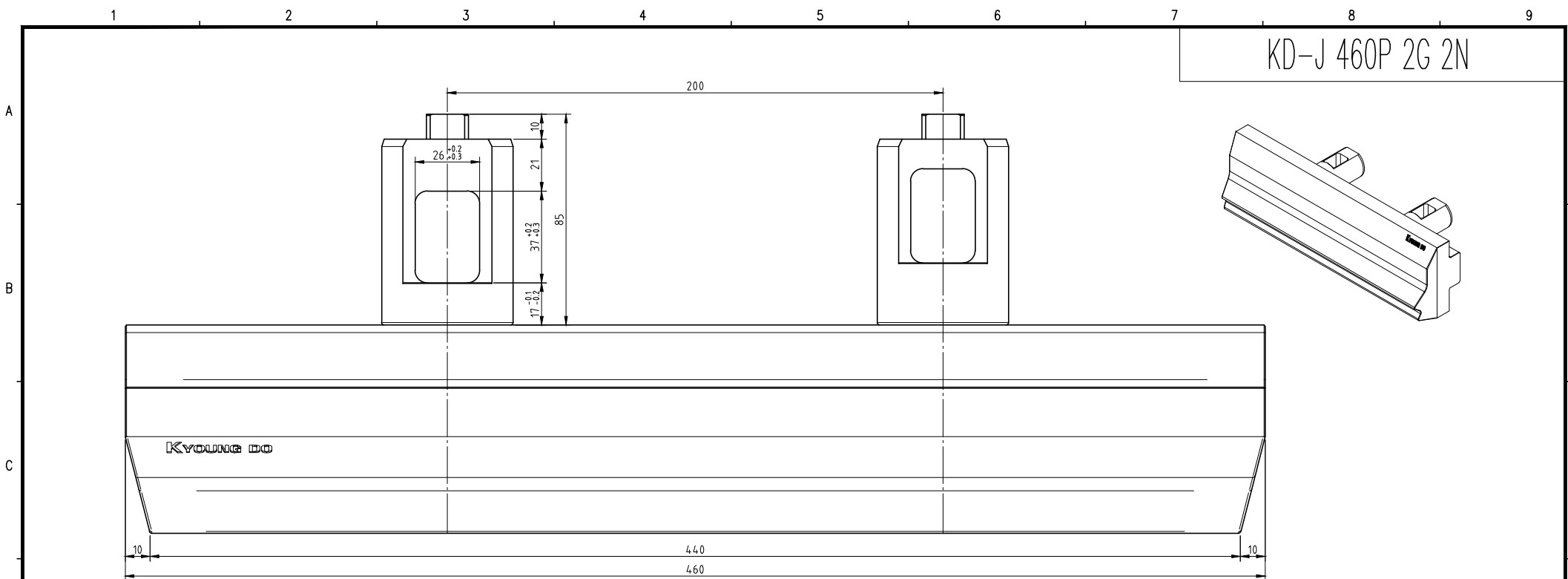

JAW / MAT'L : SKD61

SHAFT / MAT'L : SCM440

JAW / Q.T : Hs 70 ±3

SHAFT / Q.T : Hs 45 ±3